

Technical
Drawing

Desenho
Técnico

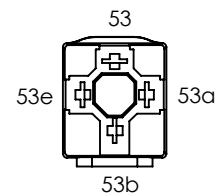
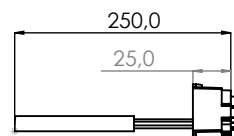
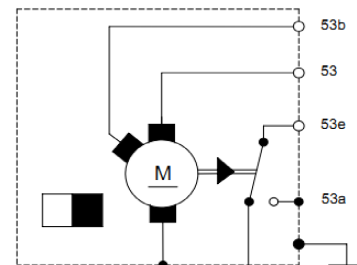
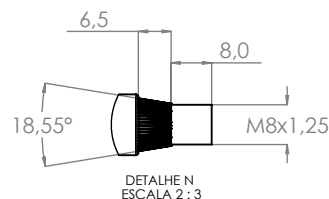
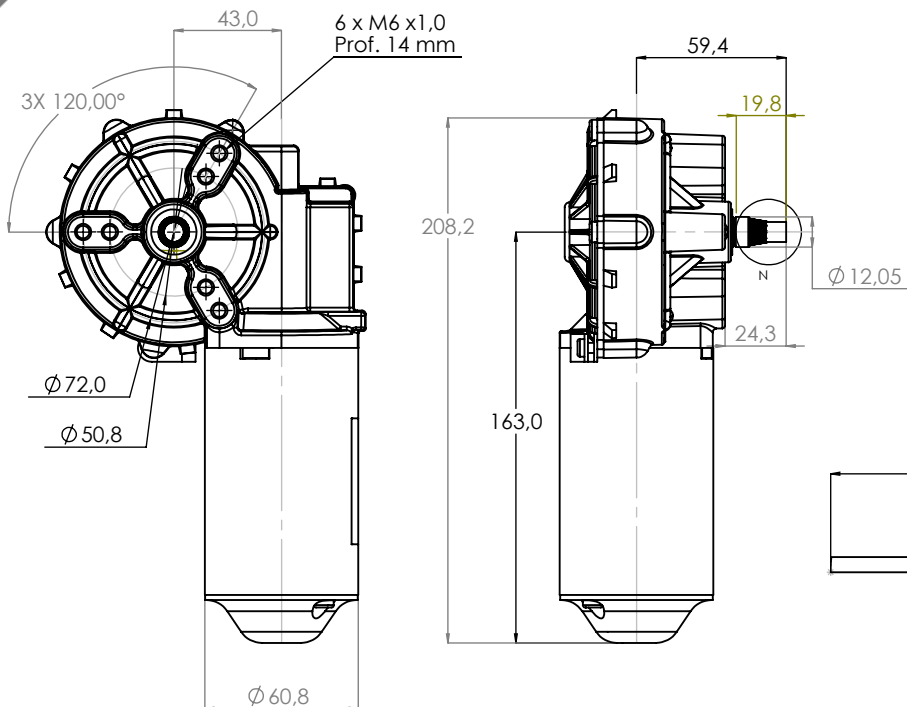

Legenda Ligação		
53	Vel.1	Azul
53a	Positivo	Vermelho
53b	Vel. 2	Branco
53e	Retorno	Preto

Technical
Specification

Especificação
Técnica

Imagem
Ilustrativa

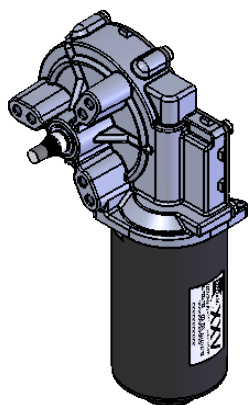

100511112

CARACTERÍSTICAS ELÉTRICAS

U_N	13 V	[V]	
	VI	VII	
P_N	25	35	[W]
n_N	29	41	[rpm]
I_N	5,5	6,5	[A]
$I_{máx.}$	23	25	[A]
M_N	8	8	[Nm]
$M_{máx.}$	49	45	[Nm]
i	55:1		
Rot.	L		
Massa	1,7 kg	[kg]	

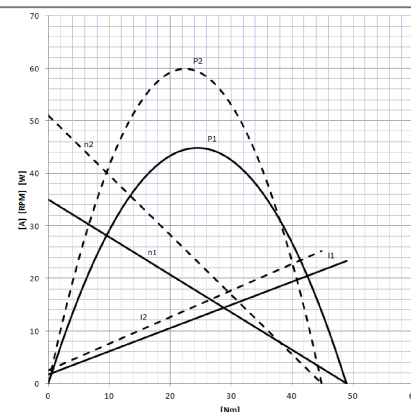

Aplicação: Diversos

100511124

CARACTERÍSTICAS ELÉTRICAS

U_N	27 V	[V]	
	VI	VII	
P_N	20	33	[W]
n_N	30	51	[rpm]
I_N	2,2	3	[A]
$I_{máx.}$	10,5	13,5	[A]
M_N	6	6	[Nm]
$M_{máx.}$	50	49	[Nm]
i	55:1		
Rot.	L		
Massa	1,5 kg	[kg]	

