

Technical
Drawing

Desenho
Técnico

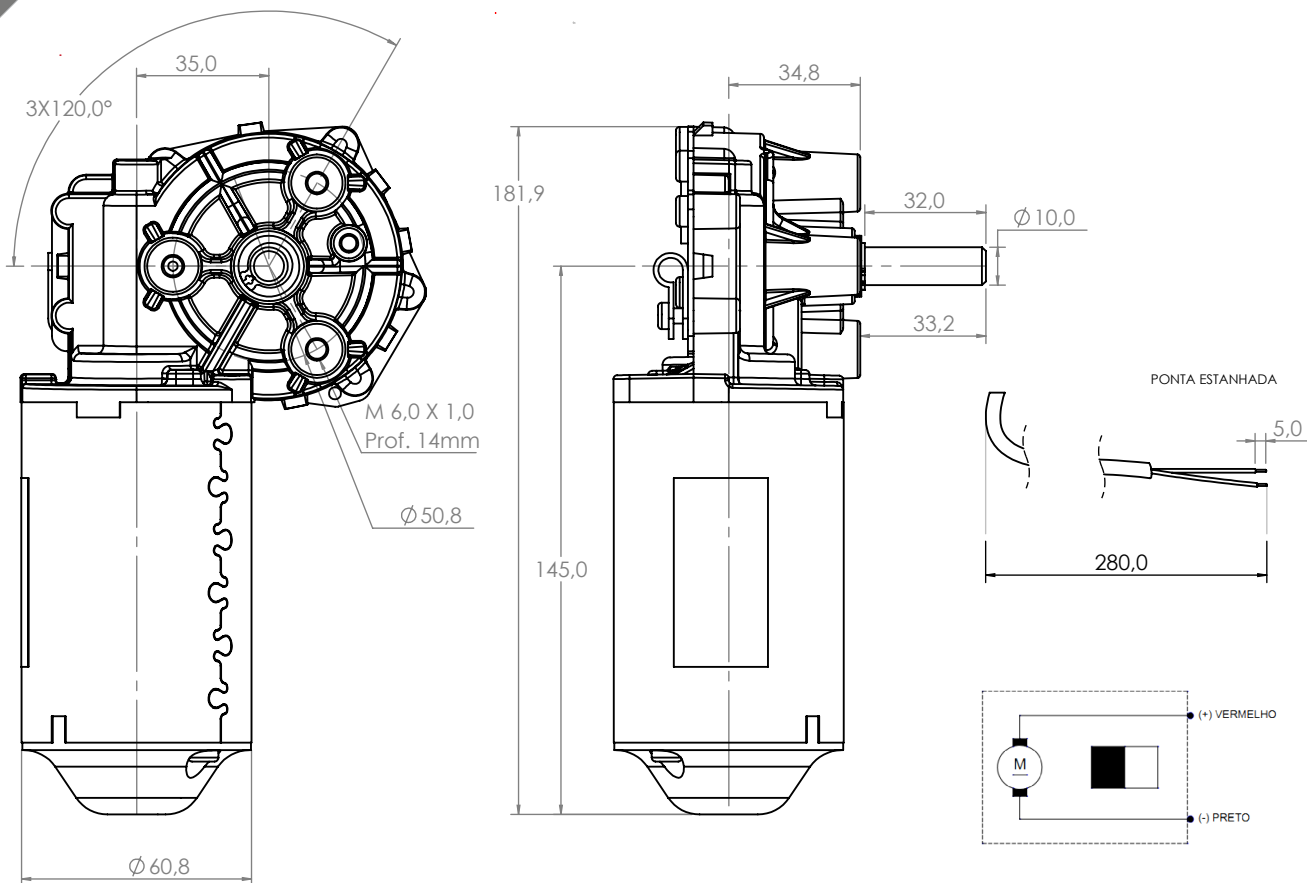

Technical
Specification

Especificação
Técnica

Imagem
Ilustrativa

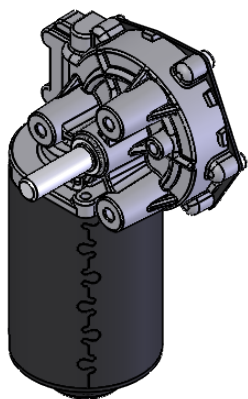

100401512

CARACTERÍSTICAS ELÉTRICAS	
Un	13 V
VI	
Pn	40 W
Nn	63 RPM
In	7,5 A
I Máx	45,5 A
Mn	6 N.m
M máx	30 N.m
i	63:1
Rot	L / R
Kg	1,3 Kg

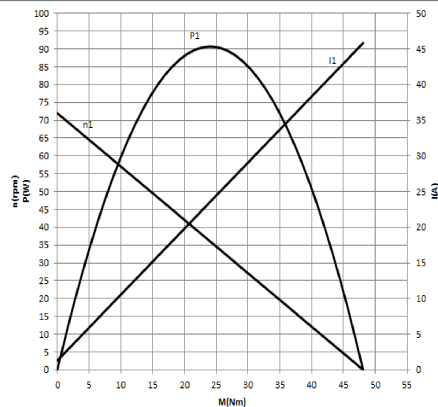

100401524

CARACTERÍSTICAS ELÉTRICAS	
Un	27 V
VI	
Pn	45 W
Nn	72 RPM
In	4 A
I Máx	29 A
Mn	6 N.m
M máx	30 N.m
i	63:1
Rot	L / R
Kg	1,3 Kg

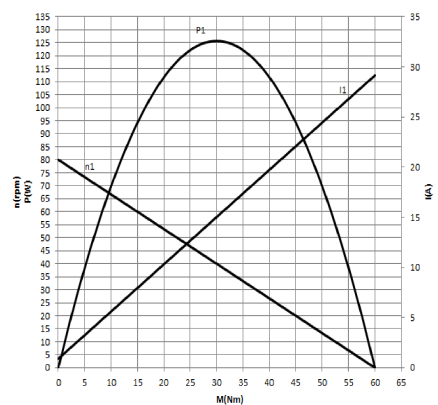

Aplicação: Industrial