

Technical Drawing

Desenho Técnico

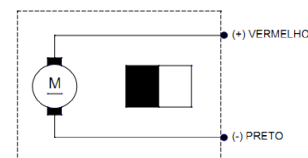
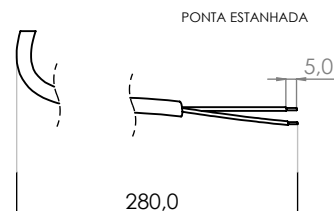
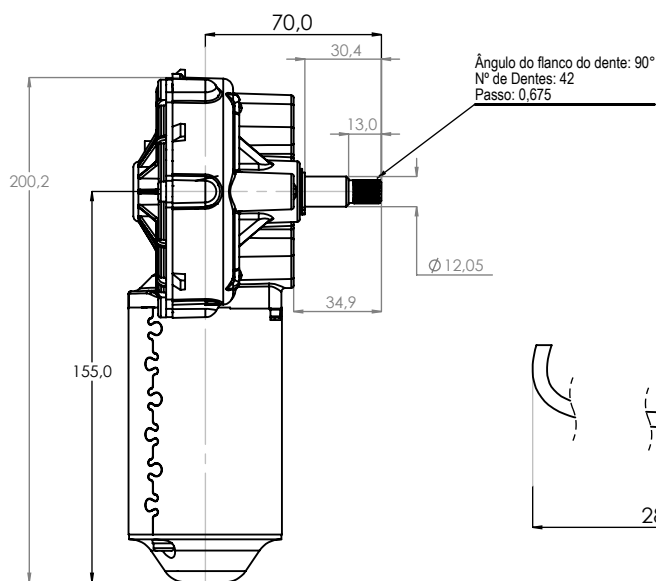
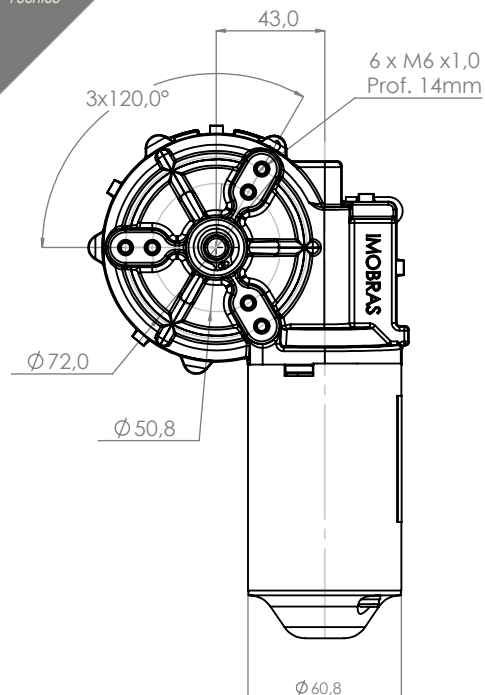

Technical Specification

Especificação Técnica

Imagem Ilustrativa

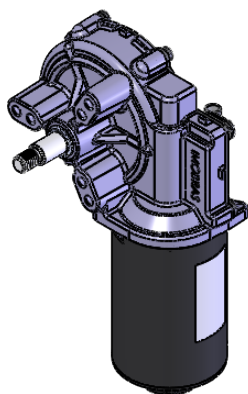

**100500112**

CARACTERÍSTICAS ELÉTRICAS

U N (V)	13
P N (W)	21
n N (rpm)	30
I N (A)	3,5
I max (A)	17
M N (Nm)	6
M max (Nm)	39
I	55:1
Rotação	L/R
Peso (Kg)	1,500

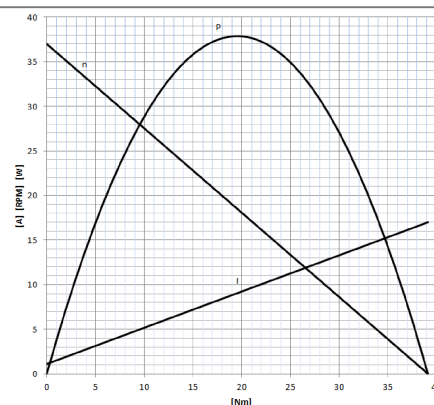

NOTAS:

Aplicação: Industrial

NOTES:

Application: Industrial