

Technical  
Drawing

Desenho  
Técnico

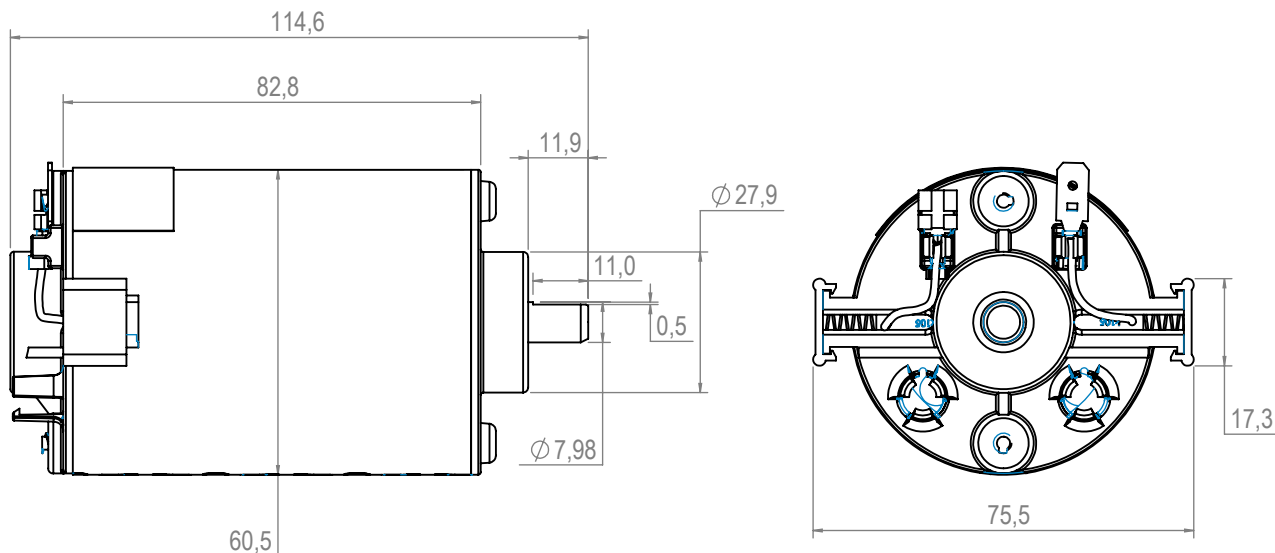

Technical  
Specification

Especificação  
Técnica

Imagem  
Ilustrativa

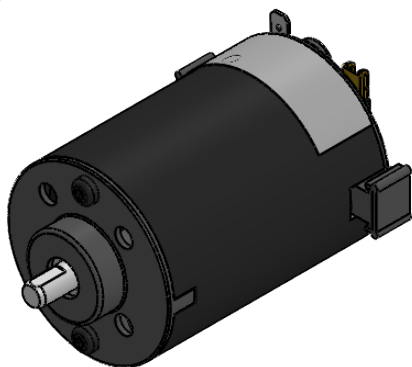

101411012

Valores Nominais	
Tensão (V)	13
Corrente (A)	6,4
Potência (W)	60
RPM (min <sup>-1</sup> )	3600
TORQUE (N.m)	0,15
Peso (Kg)	1,000

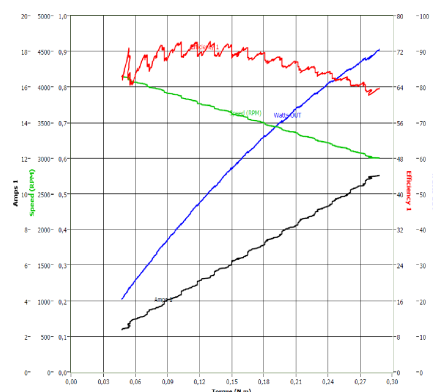

101411024

Valores Nominais	
Tensão (V)	27
Corrente (A)	3,25
Potência (W)	62
RPM (min <sup>-1</sup> )	4000
TORQUE (N.m)	0,15
Peso (Kg)	1,000

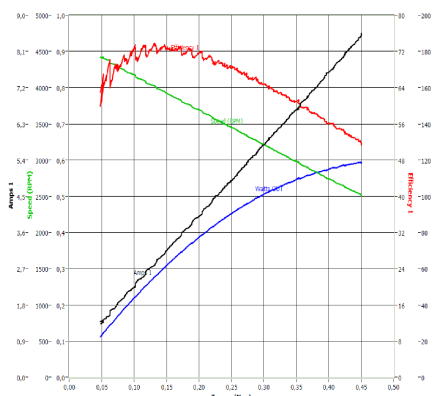

Notas:

-Aplicação: Industrial

Notes:

-Application: Industrial